

MITSUBISHI

A/D Converter Module Type A1S64AD

User's Manual

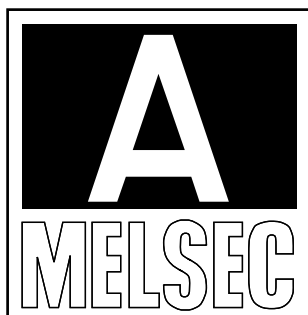
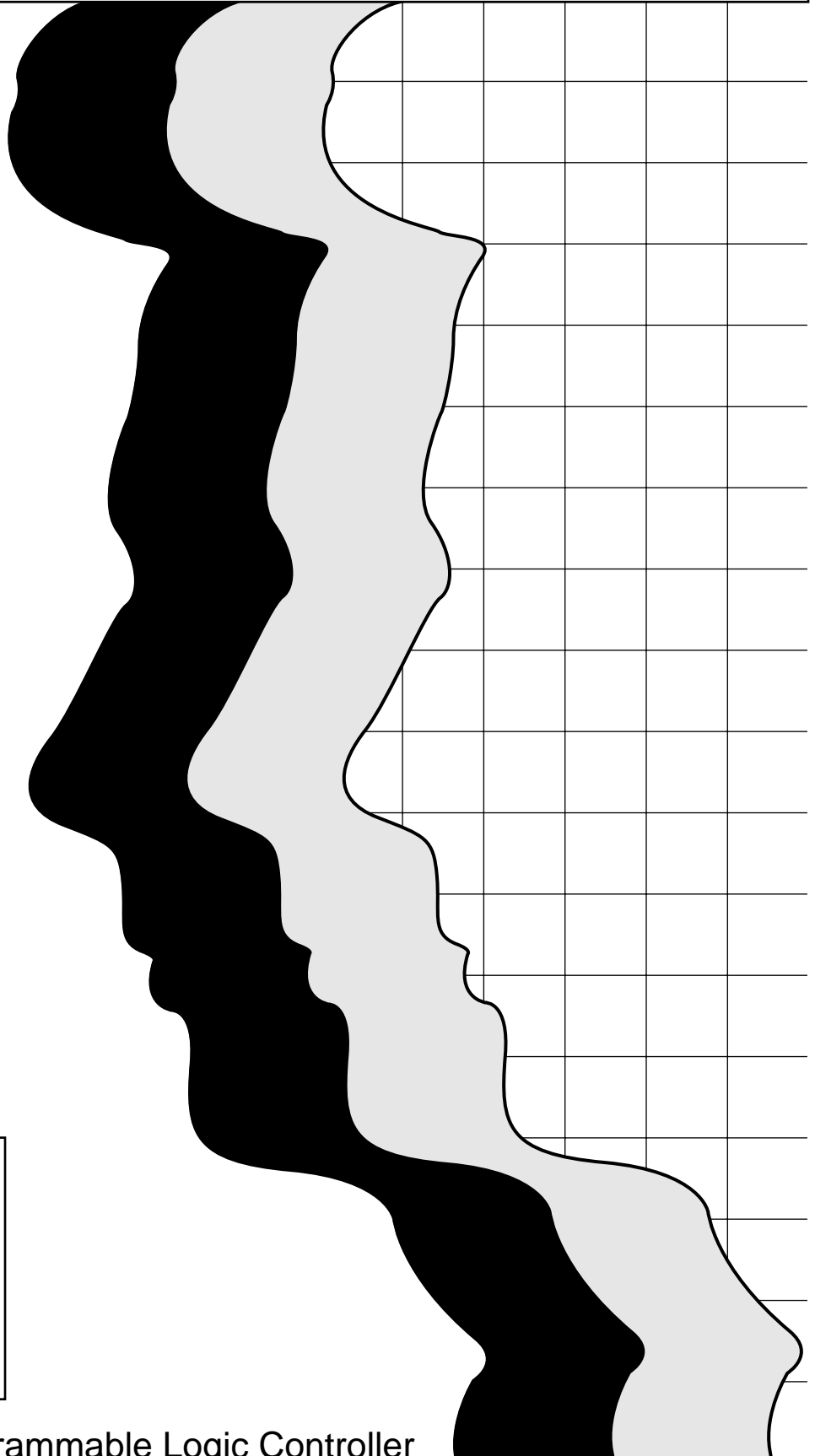

Mitsubishi Programmable Logic Controller

● SAFETY PRECAUTIONS ●

(Always read these instructions before using this equipment.)

Before using this product, please read this manual and the relevant manuals introduced in this manual carefully and pay full attention to safety to handle the product correctly.

The instructions given in this manual are concerned with this product. Refer to the User's Manual of the CPU module in use for details on the safety instructions for the programmable logic controller system.

In this manual, the safety instructions are ranked as "DANGER" and "CAUTION".



DANGER

Indicates that incorrect handling may cause hazardous conditions, resulting in death or severe injury.



CAUTION

Indicates that incorrect handling may cause hazardous conditions, resulting in medium or slight personal injury or physical damage.

Note that the  **CAUTION** level may lead to a serious consequence according to the circumstances. Always follow the instructions of both levels because they are important to personal safety.

Please save this manual to make it accessible when required and always forward it to the end user.

[DESIGN PRECAUTIONS]

CAUTION

- Do not bunch the control wires or communication cables with the main circuit or power wires, or install them close to each other.
They should be installed 100mm (3.94inch) or more from each other.
Not doing so could result in noise that would cause erroneous operation.

[INSTALLATION PRECAUTIONS]

CAUTION

- Use the PLC in an environment that meets the general specifications given in the User's Manual of the CPU module in use.
Using this PLC in an environment outside the range of the general specifications could result in electric shock, fire, erroneous operation, and damage to or deterioration of the product.
- Install so that the pegs on the bottom of the module fit securely into the base unit peg holes, and use the specified torque to tighten the module's fixing screws.
Not installing the module correctly could result in erroneous operation, damage, or pieces of the product falling.

[WIRING PRECAUTIONS]

CAUTION

- Ground the AG and FG terminals especially when high levels of noise are identified. Failure to observe this could lead to erroneous operation.
- When wiring in the PLC, be sure that it is done correctly by checking the product's rated voltage and the terminal layout. Connecting a power supply that is different from the rating or incorrectly wiring the product could result in fire or damage.
- Tightening the terminal screws with the specified torque. If the terminal screws are loose, it could result in short circuits, fire, or erroneous operation. Tightening the terminal screws too far may cause damages to the screws and/or the module, resulting in fallout, short circuits, or malfunction.
- Be sure there are no foreign substances such as sawdust or wiring debris inside the module. Such debris could cause fires, damage, or erroneous operation.

[STARTUP AND MAINTENANCE PRECAUTIONS]

DANGER

- Do not touch the terminals while power is on. Doing so could cause shock or erroneous operation.
- Be sure to shut off all phases of the external power supply used by the system before cleaning or retightening the terminal screws. If you do not switch off the external power supply, it will cause failure or malfunction of the module.

CAUTION

- Do not disassemble or modify the module. Doing so could cause trouble, erroneous operation, injury, or fire.
- Be sure to shut off all phases of the external power supply used by the system before mounting or dismounting the module. If you do not switch off the external power supply, it will cause failure or malfunction of the module.
- Do not install/remove the terminal block more than 50 times after the first use of the product. (IEC 61131-2 compliant)
- Before handling the module, always touch grounded metal, etc. to discharge static electricity from the human body. Failure to do so can cause the module to fail or malfunction.

[DISPOSAL PRECAUTIONS]

CAUTION

- When disposing of the product, handle it as industrial waste.

REVISIONS

*The manual number is given on the bottom left of the back cover.

Print Date	*Manual Number	Revision
Sep., 1991	IB (NA) 66336-A	First edition
May, 2000	IB (NA) 66336-B	<div style="border: 1px solid black; padding: 2px; display: inline-block;">Addition</div> SAFETY PRECAUTIONS, WARRANTY <div style="border: 1px solid black; padding: 2px; display: inline-block;">Correction</div> Chapter 2, Section 3.1, 3.2, 3.3.3, 3.7.1, 4.1, 4.4.2, 5.1, 5.3
Oct., 2002	IB (NA) 66336-C	<div style="border: 1px solid black; padding: 2px; display: inline-block;">Part Addition</div> CONTENTS, Section 6.2.4 <div style="border: 1px solid black; padding: 2px; display: inline-block;">Correction</div> Section 3.1, 3.2, 3.3.1, 3.3.2, 4.3, 4.4.2
Sep., 2004	IB (NA) 66336-D	<div style="border: 1px solid black; padding: 2px; display: inline-block;">Correction</div> SAFETY PRECAUTIONS, Conformation to the EMC Directive and Low Voltage Instruction, Section 3.2, 3.3.1, 3.3.2, 3.5.1, 3.7.2, 3.7.3, 4.3, Chapter 5, Section 6.1, 6.2, 6.2.2, 6.2.5, WARRANTY
Sep., 2006	IB (NA) 66336-E	<div style="border: 1px solid black; padding: 2px; display: inline-block;">Correction</div> SAFETY PRECAUTIONS

INTRODUCTION

Thank you for choosing the Mitsubishi MELSEC-A Series of General Purpose Programmable Controllers. Please read this manual carefully so that the equipment is used to its optimum. A copy of this manual should be forwarded to the end User.

CONTENTS

1. INTRODUCTION	1-1
1.1 Features	1-1
2. SYSTEM CONFIGURATIONS	2-1
3. SPECIFICATIONS	3-1 ~ 3-17
3.1 General Specifications	3-1
3.2 Performance Specifications	3-2
3.3 I/O Conversion Characteristics	3-3
3.3.1 Voltage input characteristics	3-4
3.3.2 Current input characteristics	3-5
3.3.3 Relationship between the offset/gain setting and the digital output value	3-6
3.4 Function List	3-8
3.5 Maximum Conversion Speed	3-9
3.5.1 Conversion speed for one channel	3-9
3.5.2 Influence on the maximum conversion speed by executing the FROM/TO instruction	3-9
3.6 CPU I/O Signal	3-10
3.6.1 Overview of I/O signals	3-10
3.6.2 I/O signal functions	3-11
3.7 Buffer Memory	3-12
3.7.1 Buffer memory assignment	3-12
3.7.2 Setting of A-D conversion enable/disable	3-13
3.7.3 Setting of the sampling process/averaging process	3-14
3.7.4 Digital output value	3-16
3.7.5 Writing data error code	3-16
3.7.6 A-D conversion completed flag	3-17
3.7.7 Resolution setting	3-17
4. PRE-OPERATION SETTINGS AND PROCEDURES	4-1 ~ 4-5
4.1 Handling Instructions	4-1
4.2 Nomenclature	4-2
4.3 Offset/gain Setting	4-3
4.4 Wiring	4-4
4.4.1 Wiring instructions	4-4
4.4.2 Connection example of module	4-5
4.5 Check and Maintenance	4-5
5. PROGRAMMING	5-1 ~ 5-4
5.1 Programming Procedure	5-1
5.2 Basic Program for Read/Write	5-2
5.3 Initial Setting Program and Example of Digital Output Value Read Program	5-3

6. TROUBLESHOOTING	6-1 ~ 6-3
6.1 Error Code List	6-1
6.2 Troubleshooting	6-2
6.2.1 When the RUN LED of A1S64AD Flashes	6-2
6.2.2 When the RUN LED of A1S64AD goes OFF	6-2
6.2.3 When the digital output value cannot be read	6-2
6.2.4 When the A-D conversion complete flag is not turned ON	6-3
 APPENDICES	 APP-1 ~ APP-2
Appendix 1 Outside Dimensions	APP-1
Appendix 2 Signal Paper	APP-2

Conformation to the EMC Directive and Low Voltage Instruction

For details on making Mitsubishi PLC conform to the EMC directive and low voltage instruction when installing it in your product, please see Chapter 3, "EMC Directive and Low Voltage Instruction" of the User's Manual (Hardware) of the PLC CPU to use.

The CE logo is printed on the rating plate on the main body of the PLC that conforms to the EMC directive and low voltage instruction.

By making this product conform to the EMC directive and low voltage instruction, it is not necessary to make those steps individually.

1. INTRODUCTION

This manual describes specifications, handling, programming and other information on the A1S64AD analog to digital converter module (referred to as "A1S64AD") for use with a MELSEC-A series A1SCPU module (hereafter called the CPU).

A1S64AD is used to convert an analog signal (voltage or current input) from an external device of a PC into a digital value signed 16 bit BIN data.

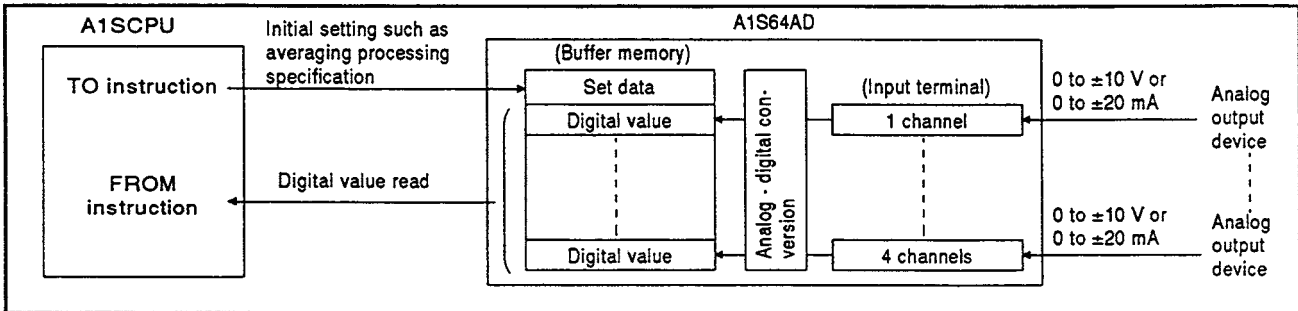

1.1 Features

A1S64AD has the following features.

- (1) Allows analog to digital conversion for 4 channels. A-D conversion of 4 channels is enabled with an A1S64AD.

The voltage input and the current input can be selected for every channel.

- (2) Allows high resolution of 1/12000 (all channels in the batch).

The resolution of a digital value can be set at either 1/4000, 1/8000 or 1/12000, and a high resolution digital value can be obtained.

- (3) Allows average processing within a specified time or within a number of times. (Every channel)

- (a) Sampling the processing method for outputting a digital value every time of A-D conversion.

- (b) The A-D conversion of a channel when the average processing method was specified and is executed for the set number of times or the set time. The average processing method for outputting the mean value as a digital value can then be selected for every channel.

- (4) Allows conversion of the enable/disable setting. (Every channel)

The A/D conversion of the enable/disable setting can be set for every channel. The conversion speed can then be shortened by setting an unused channel to conversion disable.

- (5) Allows an offset/gain adjustment to be made without using the offset/gain adjusting knobs. (Every channel)

An offset value and a gain value can be adjusted by inputting a set voltage or current and turning ON the setting switch.

2. SYSTEM CONFIGURATIONS

The following diagram show the overall configurations when using the A1S64AD with CPUs in the MELSEC-A series.

(1) Applicable CPUs

- A1SJCPU (S3)
- A1SJHCPU (S8)
- A1SCPU (S1)
- A1SCPUC24-R2
- A1SHCPU
- A2SCPU (S1)
- A2SHCPU (S1)
- A2ASCPU (S1/S30)
- A2USHCPU-S1
- Q2ASCPU (S1)
- Q2ASHCPU (S1)
- A52GCPU (T21B)

(2) Number of mounted modules

There is no limit to the number of modules that can be used as long as the total is within the input point range for the applicable CPU.

(3) Mounting slot

The module can be mounted into a random slot on the base unit, except in the following cases.

If the module is mounted into an extension base unit (A1S52B, A1S55B, A1S58B) having no power supply unit, the power capacity may be insufficient. When mounting the A1S64AD onto an extension base unit with no power supply unit, consider the following matters:

- 1) Current capacity of power supply unit on main base unit
- 2) Voltage drop at main base unit
- 3) Voltage drop at extension base unit
- 4) Voltage drop at extension cable.

Select the power supply unit, main base unit, extension base unit and extension cables taking the above matters into consideration.

(4) Data link system

In the data link system, the CPU can be mounted onto the master station, local station or remote I/O station. Refer to the MELSECNET and MELSECNET/B Data Link System Reference Manual for examples of the remote I/O station programs.

REMARKS

Refer to the following manuals for details on the range of number of occupied I/O points and the method of calculating the voltage drop.

- Type A1SJCPU(S3) User's Manual..... IB (NA)-66446
- Type A1S/A1SC24-R2/A2SCPU (S1) User's Manual IB (NA)-66320
- Type A2ASCPU (S1) User's Manual IB (NA)-66455
- A52GCPU(T21B)User's Manual..... IB-66419
- A52GCPU(T21B)Reference Manual..... IB-66420
- Type A1SJH(S8)/A1SH/A2SHCPU(S1)User's Manual..... IB-66779
- Type A2USHCPU-S1 User's Manual..... IB-66789
- Model Q2AS(H)CPU(S1) User's Manual..... SH-3599

3. SPECIFICATIONS

MELSEC-A

3. SPECIFICATIONS

This chapter describes the general specifications, performance specifications, and I/O conversion characteristics of the A1S64AD.

3.1 General Specifications

The following table shows the general specifications of the A1S64AD.

Table 3.1 General Specifications

Item	Specifications					
Operating ambient temperature	0 to 55°C					
Storage ambient temperature	-20 to 75°C					
Operating ambient humidity	10 to 90%RH, No condensation					
Storage ambient humidity	10 to 90%RH, No condensation					
Vibration resistance	Conforming to JIS B 3502, IEC 61132-2	When there is intermittent vibration	Frequency	Acceleration	Amplitude	Sweep Count 10 times each in X, Y and Z axis (80 minutes)
			10 to 57Hz	-	0.075mm	
		When there is continuous vibration	57 to 150Hz	9.8m/s ²	-	
			10 to 57Hz	-	0.035mm	
57 to 150Hz	4.9m/s ²	-				
Shock resistance	Conforming to JIS B 3502, IEC 61131-2 (147m/s ² , 3 times each in 3 directions)					
Operating environment	No corrosive gas present					
Operating height	2000m (6562ft.) or less					
Installation area	On the control board					
Over-voltage category ^{*1}	II or less					
Pollution degree ^{*2}	2 or less					

***1:** Indicates the distribution area where the device is assumed to be connected, from the public power distribution network to the local machine device.

Category II is applied to the devices to which the power is supplied from a fixed equipment.

The surge resistance voltage of a rated 300V device is 2500V.

***2:** This is an index which indicates the occurrence rate of the conductive object in the environment where the device is used.

Pollution degree 2 indicates that only non-conductive pollution may occur with a possibility of generating temporary conductivity due to accidental condensation.

***3:** Do not use or install the PLC in the environment where higher atmospheric pressure is applied than at 0m elevation.

Failure to observe this may result in malfunction.

Please consult your local Mitsubishi representative on use of PLC under increased pressure.

3. SPECIFICATIONS

MELSEC-A

3.2 Performance Specifications

Table 3.2 shows the performance specifications of the A1S64AD.

Table 3.2 Performance Specifications

Item	Specifications			
Analog input	Voltage : -10 to 0 to 10VDC (Input resistance: 1M Ω) Current : -20 to 0 to 20mA (Input resistance: 250 Ω)			Selectable by input terminals
Digital output	Signed 16-bit binary 1/4000 setting: -4096 to 4095 1/8000 setting: -8192 to 8191 1/12000 setting: -12288 to 12287			
I/O characteristics *1	Analog Input	Digital output (Gain: 5V/20mA, Offset: 0V/0mA)		
		1/4000	1/8000	1/12000
	10V	+4000	+8000	+12000
	5V or 20mA	+2000	+4000	+6000
	0V or 0mA	0	0	0
	-5V or -20mA	-2000	-4000	-6000
		1/4000	1/8000	1/12000
Maximum resolution	Voltage input	2.5mV	1.25mV	0.83mV
	Current input	10 μ A	5 μ A	3.33 μ A
Overall accuracy *2	$\pm 1\%$	± 40	± 80	± 120
Maximum conversion time	Maximum 20 msec/channel			
Absolute maximum output	Voltage: ± 15 V Current: ± 30 mA			
Analog input points	4 channels/module			
Isolation specifications	Specific isolated area	Isolation method	Dielectric withstand voltage	Insulation resistance
	Between input terminal and PLC power supply	Photocoupler isolation	500V AC for 1 minute	5M Ω or more (measured with a 500V DC insulation resistance tester)
	Between channels	Not isolated	-	-
Number of I/O points	32 points			
Connection terminal	20 points terminal block			
External power supply	Not required			
Applicable wire size	0.75 to 1.5mm ²			
Applicable solderless terminal	1.25-3, 1.25-YS3, V1.25-3, V1.25-YS3A			
Internal current consumption(5V)	0.4A			
Weight	0.25kg			

*1 The gain value is set to 5V/20mA and the offset value is set to 0V/4mA at factory.

*2 This is the accuracy in respect to the maximum digital output value. The maximum digital output value is the maximum value of the selected resolution. The value is the same for the current input and voltage input.

POINT

The available analog input range for the maximum resolution and overall accuracy is as follows:

Voltage: -10 to 0 to +10 V
Current: -20 to 0 to +20 mA

3.3 I/O Conversion Characteristics

I/O characteristics are provided to convert an analog signal from an external device into a digital value and are indicated by an inclination connected between an offset value and a gain value.

Offset value is the analog input value (current or voltage) when the digital output value is "0".

Gain value is the analog input value (current or voltage) when the digital output value is 2000 (resolution: 1/4000), 4000 (resolution: 1/8000), or 6000 (resolution: 1/12000).

The figure below shows an example of the I/O conversion characteristics of A1S64AD.

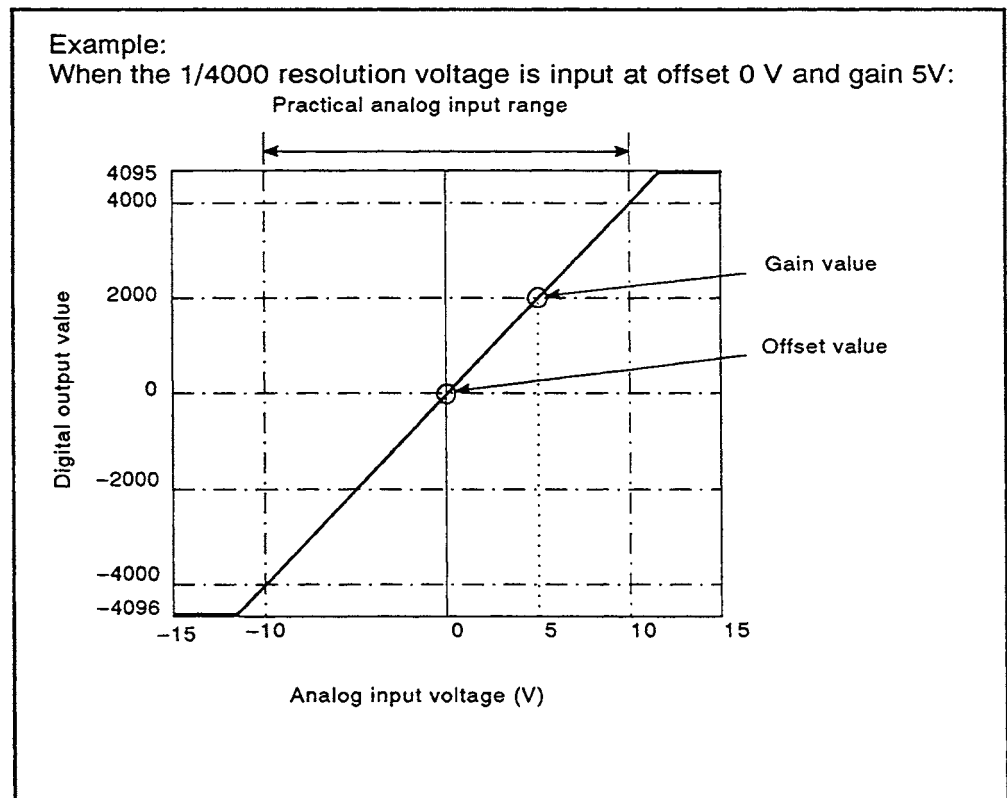

Fig. 3.1 I/O Conversion Characteristics

3. SPECIFICATIONS

3.3.1 Voltage input characteristics

The figure below shows an example of the voltage input characteristics when offset/gain setting is changed.

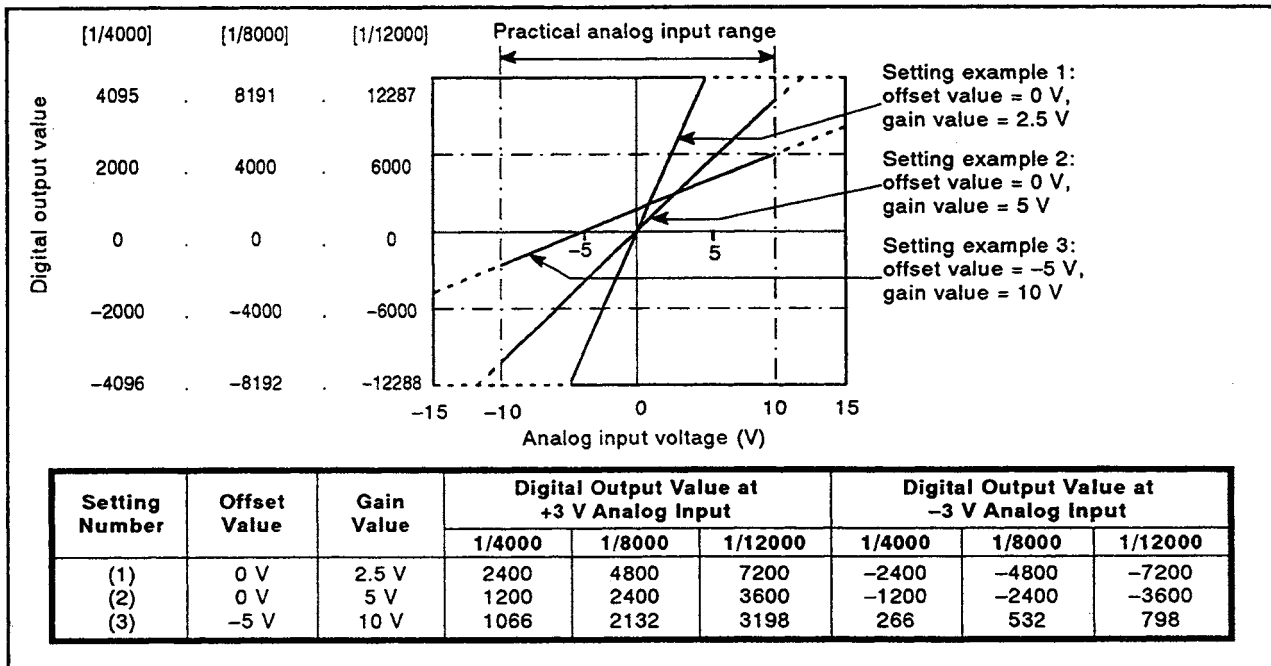

Fig 3.2 Voltage Input Characteristics

POINT

- (1) Do not input voltage ± 15 V or more. Otherwise, elements may be broken.
- (2) When the input voltage is from -10 to 10 V, the maximum resolution and overall accuracy will be within the specifications range. However, if the input voltage is outside this range, the accuracy will sometimes not match with the specifications. (Do not use a value within the range corresponding to "-----" in the figure 3.2.)
- (3) When an analog is input, that causes a digital output value beyond the maximum (4095, 8191, or 12287) or minimum (-4096 , -8192 , -12288) of the digital resolution, the digital output value is fixed to the maximum (4095, 8191, or 12287) or minimum (-4096 , -8192 , or -12288) of the digital resolution.
- (4) Follow the conditions below to set the offset/gain. If the settings do not match these conditions, correct characteristics cannot be guaranteed. This disables the A-D conversion completed flag (Buffer memory address: 19) from turning ON.
For example, if the same value is set to the offset and gain values, the digital value remains in 0.
Set the offset and gain values again.

$$(\text{Gain value}) - (\text{Offset value}) > n$$

Resolution	n (V)
1/4000	1.0
1/8000	1.5
1/12000	2.0

3. SPECIFICATIONS

3.3.2 Current input characteristics

The figure below shows an example of the current input characteristics when the offset/gain setting is changed.

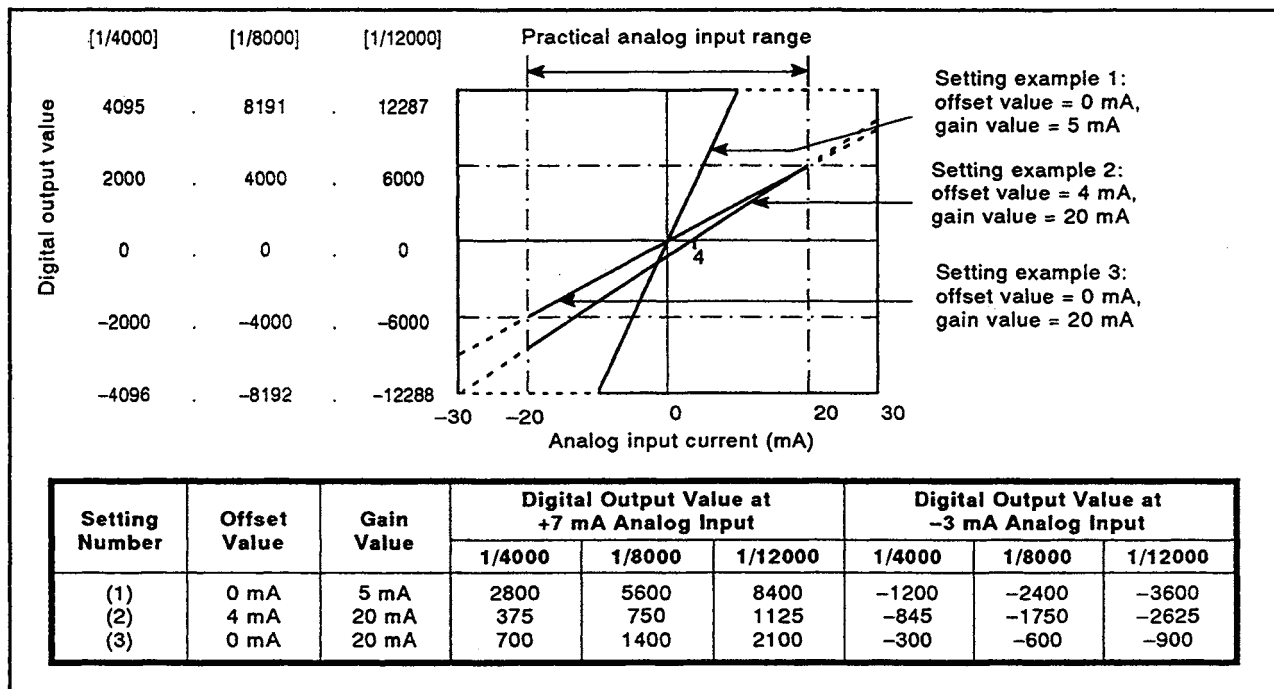

Fig 3.3 Voltage Input Characteristics

POINT

- (1) Do not input a voltage ± 30 mA or more. Otherwise, a high temperature will occur and cause a problem.
- (2) When the input voltage is from -20 to 20 mA, the maximum resolution and overall accuracy is in the range of specifications. However, if the input voltage is not within this range, the accuracy does not sometimes match with the specifications. (Do not use the value within the range corresponding to "-----" in the figure 3.3.)
- (3) When the analog is input, which causes the digital output value beyond the maximum (4095, 8191, or 12287) or minimum (-4096 , -8192 , -12288) of the digital resolution, the digital output value is fixed to the maximum (4095, 8191, or 12287) or minimum (-4096 , -8192 , or -12288) of the digital resolution.
- (4) Follow the conditions below to set the offset/gain. If the settings do not match these conditions, correct characteristics cannot be guaranteed. This disables the A-D conversion completed flag (Buffer memory address: 19) from turning ON.
For example, if the same value is set to the offset and gain values, the digital value remains in 0.
Set the offset and gain values again.

$$(\text{Gain value}) - (\text{Offset value}) > n$$

Resolution	n (mA)
1/4000	4.0
1/8000	6.0
1/12000	8.0

3.3.3 Relationship between the offset/gain setting and the digital output value

The following explains the relationship between offset/gain setting and digital output value.

(1) Resolution

Resolution is calculated by using the following formula.

• Voltage input

$$\text{Resolution} = \frac{(\text{Gain value}) - (\text{Offset value})}{2000(1/4000)/4000(1/8000)/6000(1/12000)} \times 1000 \text{ (mV)}$$

• Current input

$$\text{Resolution} = \frac{(\text{Gain value}) - (\text{Offset value})}{2000(1/4000)/4000(1/8000)/6000(1/12000)} \times 1000 \text{ (}\mu\text{A)}$$

(2) Maximum resolution and digital output value

The maximum resolution of the A1S64AD is as shown in Table 3.2 Performance Specifications, so if the following expression is used with the offset/gain setting, the digital output value will not increment or decrement by one.

$$\frac{(\text{Gain value}) - (\text{Offset value})}{2000/4000/8000} \times 1000 < \text{Maximum resolution}$$

3. SPECIFICATIONS

(3) Overall accuracy

The overall accuracy is the accuracy of the maximum value of digital output. If the I/O characteristics are changed by changing the offset/gain setting, the overall accuracy may be kept within the specifications range.

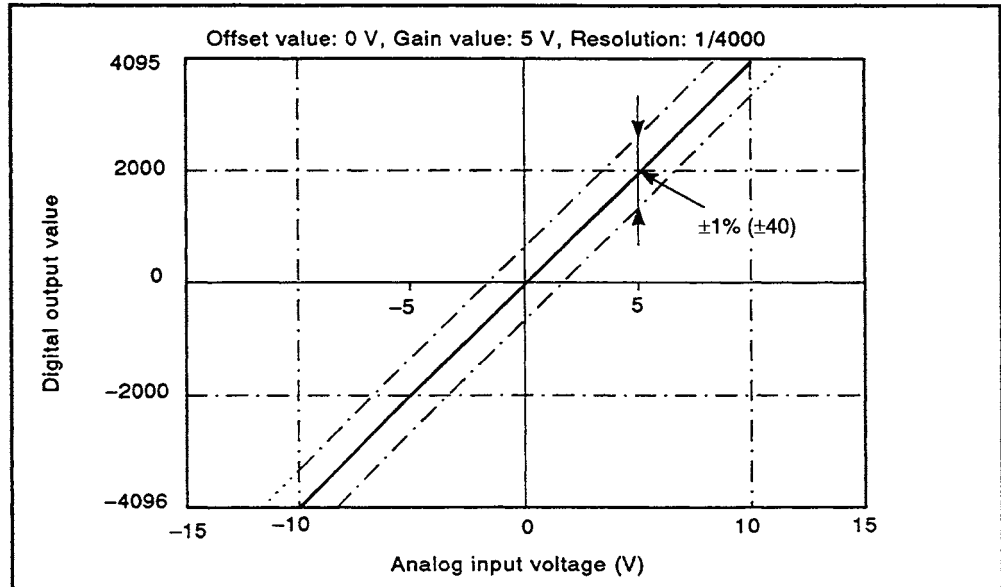

Fig 3.4 Overall Accuracy of the Voltage Input Characteristics

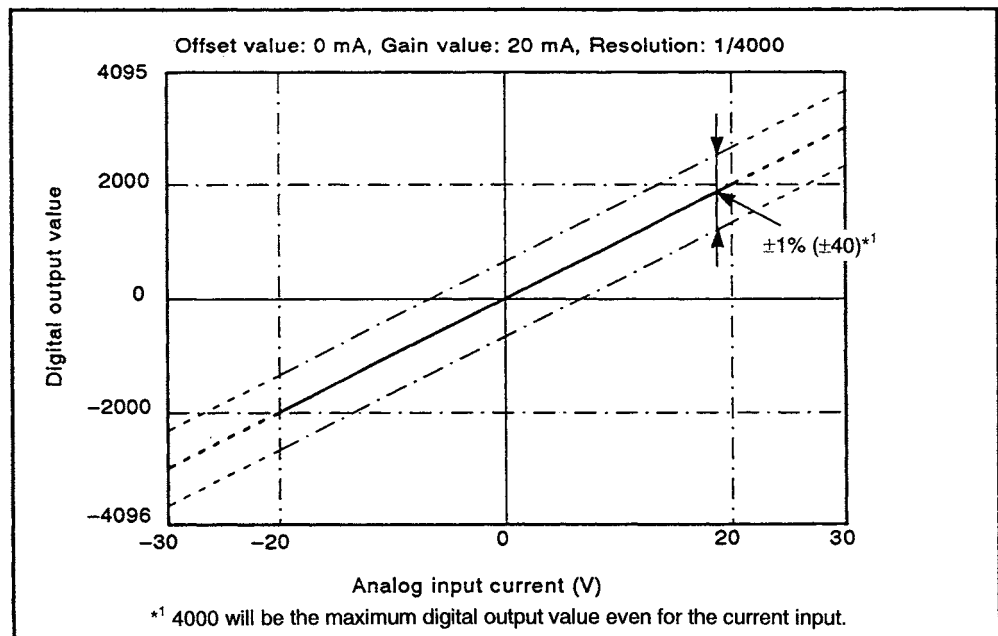

Fig 3.5 Overall Accuracy of the Current Input Characteristics

3.4 Functions List

Table 3.1 shows the functions of A1S64AD.

Table 3.1 A1S64AD Functions List

Item	Description	Reference
A-D conversion-enable/disable setting	<ul style="list-style-type: none"> • A-D conversion enable/disable is specified for each channel. (Default: All channels are set to "enable".) • Sampling time can be shortened by switching the unused channel to "disable". 	Section 3.7.2
Offset/gain setting	<ul style="list-style-type: none"> • Offset and gain can be set without using the offset/gain adjusting knobs. Therefore, the I/O characteristics can be changed. 	Section 3.3
Averaging process specification	<ul style="list-style-type: none"> • A-D conversion is done for the each channel with a setting count or setting time. The averaging process is done for the A-D conversion data, and the average is set to the buffer memory as the digital output value. 	Section 3.7.3
Sampling process specification	<ul style="list-style-type: none"> • Analog input value is converted to the digital value for each channel, and is stored in the buffer memory as the digital output value. 	Section 3.7.3

3.5 Maximum Conversion Speed

Conversion speed is the time it takes when a digital value is written to the buffer memory after the A-D conversion by switching channel.

The following explains the maximum conversion speed.

3.5.1 Conversion speed for one channel

Conversion speed for one channel of A1S64AD is 20 ms.

When several channels are used, "20 ms x the number of conversion-enabled channels" equals the sampling time.

3.5.2 Influence on the maximum conversion speed by executing the FROM/TO instruction

When the FROM/TO instruction is not executed, the maximum conversion speed is as mentioned above. Executing the FROM/TO instruction influences the maximum conversion speed as follows.

- (1) If the time it takes to write a digital value converted from an analog value overlaps with the execution of FROM/TO processing, writing to the buffer memory is delayed until the FROM/TO processing is completed.
- (2) If the time it takes for the switching channel overlaps with the execution of FROM/TO processing, the switching channel is delayed until the FROM/TO processing is completed.
- (3) When a digital value that has been converted from an analog value is being written to the buffer memory with the switching channel, the FROM/TO processing is delayed until the writing or switching channel is completed.
- (4) Designate the FROM/TO instruction to read and write a lot of data at one time. The smaller the number of FROM/TO instructions, the less the maximum conversion speed is influenced.

3.6 CPU I/O Signals

This section explains the allocation of the I/O signals and the function of each signal.

3.6.1 Overview of I/O signals

The A1S64AD uses 32 signal points for input and output.

Table 3.2 gives the allocation and description of the I/O signals.

X devices refer to the input signals from the A1S64AD to the CPU.

Y devices refer to output signals from the CPU to the A1S64AD.

The device numbers (input signals) shown in the table are used when the A1S64AD is loaded into slot 0 of the main base unit.

Table 3.2 I/O Signals

Signal Direction: A1S64AD → CPU		Signal Direction: CPU → A1S64AD	
Device No.	Signal Description	Device No.	Signal Description
X0	WDT error flag	Y0 to Y11	Unusable
X1	A-D conversion READY		
X2	Error flag	Y12	Error reset
X3 to X1F	Unusable	Y13 to Y1F	Unusable

POINT

If any of the devices (Y0 to Y11, and Y13 to Y1F) are used (turned ON/OFF) in the sequence program, the functions of the A1S64AD cannot be guaranteed.

If any of the devices Y0 to Y1F has the same number as any of the devices X0 to X1F, then the device cannot be used as an internal relay.

3. SPECIFICATIONS

3.6.2 I/O signal functions

The following table explains the function of each I/O signal of A1S64AD.

Table 3.3 I/O Signal Functions

Device No.	Signal	Description	Remark
X0	WDT (watch-dog timer) error flag (X0):	This flag is set when the self-diagnosis function of the A1S64AD detects a WDT error.	<ul style="list-style-type: none"> While the error flag is set, the A-D conversion of the A1S64AD will not RUN. If the error flag (X0) is set, hardware malfunction may occur.
X1	A-D conversion READY signal	<ul style="list-style-type: none"> This signal is turned ON when the A/D conversion is ready after turning on or resetting the CPU in a mode other than the normal mode (test mode). The A/D conversion READY signal (X1) can also be used as the buffer memory read/write interlock. If the test terminals on the front of the module are connected to each other, this signal is turned OFF. 	In this manual, "A-D conversion READY" means the time when the analog output values have been output to external equipment by executing the A-D conversion with each channel.
X2	Error flag	<ul style="list-style-type: none"> This flag is set when an error other than the watch dog timer error occurs in the A1S64AD. If the error reset signal is set, the error code is stored in the error code storage area. If the error reset signal is turned ON, this error flag is reset. 	
Y12	Error reset	<ul style="list-style-type: none"> Turning ON the error reset signal resets the error flag, and clears the check code of the buffer memory. It is replaced by "0". The RUN LED on the front of the module is switched to ON (normal operation) from flashing (error). 	<p>The diagram illustrates the timing of the error reset signal (Y12). It shows four signals: Error flag (X2), Error reset signal (Y12), Buffer memory addresses 18, and Error code. The Error flag (X2) is set by 'Set/Reset by the system'. The Error reset signal (Y12) is set by 'Set/Reset by the sequence program'. When Y12 is active, X2 is cleared and the Error code in Buffer memory addresses 18 is reset to 0.</p>

3.7 Buffer Memory

The A1S64AD has a buffer memory (not battery backed) for data communication with the CPU.

The buffer memory assignment and data maps are indicated below.

3.7.1 Buffer memory assignment

The following figure shows the buffer memory assignment

Address (Decimal)		Default Value	Read	Write	Reference
0	A-D conversion enable/disable setting	000FH (All channels are set to "enable".)	Enabled	Enabled	Section 3.7.2
1	Average processing specification	0 (All channels)	Enabled	Enabled	Section 3.7.3
2	CH1 Average time, count	0	Enabled	Enabled	Section 3.7.3
3	CH2 Average time, count				
4	CH3 Average time, count				
5	CH4 Average time, count				
6	Unusable	—	—	—	—
7					
8					
9					
10	CH1 Digital output value	0	Enabled	—	Section 3.7.4
11	CH2 Digital output value				
12	CH3 Digital output value				
13	CH4 Digital output value				
14	Unusable	—	—	—	—
15					
16					
17					
18	Write data error code	0 (No error)	Enabled	—	Section 3.7.5
19	A-D conversion completed flag	000FH (All channels)	Enabled	—	Section 3.7.6
20	Resolution setting	1(1/4000)	Enabled	Enabled	Section 3.7.7

Fig.3.6 Buffer Memory Assignment

POINT

Do not write to the buffer memory address 10 to 13 (read-only area). An error will occur if trying to write to these addresses. The RUN LED of A1S64AD will then flash and an error code will be stored in the buffer memory address 18. In addition, data is inaccurate because the A1S64AD will overwrite the data.

3.7.2 Setting of A-D conversion-enable/disable

A-D conversion-enable/disable for each channel of A1S64AD can be set at address 0 of the buffer memory by writing "1" (enable) or "0" (disable) by the channel.

The sampling period can be shortened by setting an unused channel to conversion disable.

(The default value is set to execute the A-D conversion for all channels.)

Example:

Sampling period when setting only channels 1 and 3 to A-D conversion-enable

$$2 \quad \times \quad 20 \text{ ms} \quad = \quad 40 \text{ ms}$$

(Number of enable channels) (Conversion speed of one channel)

(1) Method of setting the conversion-enable/disable

Set the conversion-enable/disable for every channel.

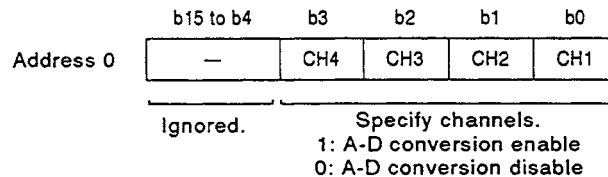

(2) Processing of A1S64AD when setting the conversion-enable/disable

(a) Initialization of the averaging process

For averaging process, initialize data in the work area in which the system of A1S64AD was stored.

Digital value stored in the buffer memory holds data before setting the conversion-enable/disable.

For example, if the conversion-enable/disable is set, (when the conversion-enable/disable specified for 50 times-average processing executes the sampling 30 times), the sampling data for 30 times is cleared and the averaging process is executed from the initial setting.

(b) Resetting of the A-D conversion completed flag

Reset the A-D conversion completed flag for channels 1 to 4 (address 19 of a buffer memory).

3.7.3 Setting of the sampling process/averaging process

- (1) Method of outputting a digital value of the sampling process and the averaging process

- (a) Sampling process

An analog input value is converted to a digital value, and the digital output value is stored in a buffer memory.

The storage time for a digital output value that the sampling process was executed on in the buffer memory depends on the number of A-D conversion-enabled channels.

Processing time =

$$\frac{(\text{number of A-D conversion-enabled channels}) \times 20 \text{ (ms)}}{\text{Maximum conversion speed}} \uparrow$$

Example:
 When channels 1, 2 and 3 are set to conversion-enable:
 $3 \times 20 = 60 \text{ (ms)}$

- (b) Averaging process

A1S64AD executes the A-D conversion for a channel that was specified for averaging process by a PLC CPU for the set number of times or set time. The total values except a maximum value and a minimum value are averaged and then stored in the buffer memory.

However, when the processing number of times is no more that two, the sampling process is executed. If A-D conversion-enable/disable is set, the average processing is initialized.

- 1) When the averaging process by time is specified

The setting time is set in 10 ms unit and a value less than 10 ms is rounded off.

Example:
 When 1234 ms is set, it is dealt with as 1230 ms.

The number of times of set processing follows the number of A-D conversion-enabled channels.

Processing time =

$$\frac{\text{Setting time}}{(\text{number of A-D conversion-enabled channels}) \times 20 \text{ (ms)}} \uparrow$$

Example:
 When the number of times of A-D conversion-enabled channels is 4 and the setting time is 8000 ms
 $8000 \div (4 \times 20) = 100 \text{ (time)}$

- 2) When the number of times for the averaging process is specified

The time in which the average is stored to the buffer memory follows the number of A-D conversion-enabled channels.

Processing time =

$$\frac{(\text{the setting number of times}) \times (\text{A-D conversion-enabled channel}) \times 20 \text{ (ms)}}{\text{Maximum conversion speed}} \leftarrow$$

3. SPECIFICATIONS

MELSEC-A

Example:

When example channels 1, 2, 3 and 4 are set to A-D conversion enable, and the setting number of times is set to 50 times

$$50 \times 4 \times 20 = 4000 \text{ (ms)}$$

- (2) Specifying the averaging process and selecting time/number of times
 - (a) When the power supply is turned ON, and the A1S64AD A-D conversion READY signal turns ON, all of the channels are specified for the sampling process.
 - (b) When sample or averaging process is required, specify the processing method.

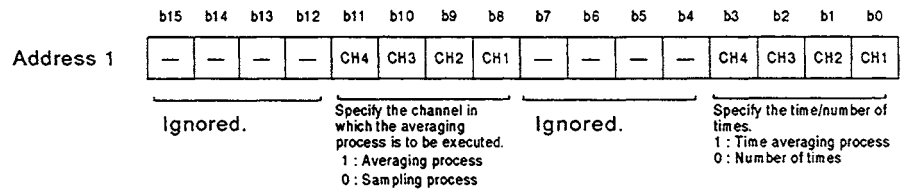

POINT

- (1) When the averaging process is specified, the number of times or time for the averaging process should be set beforehand.
- (2) When the averaging process is not specified, despite the specification of the time/number of times, sample processing will be executed.

- (3) Specifying the average time and the average number of times
 - (a) Average time or the average number of times is written in the address that corresponds to the channel of the buffer memory addresses 2 to 5 for every channel that the averaging process was specified.

Average time when a power supply is turned ON and the average number of times is set to 0.
 - (b) The allowable setting range is as follows.

Averaging process specifying the number of times: 1 to 500 times
Averaging process by specifying time: 80 to 10000 ms

POINT

When a value is set and written outside the above range, a setting error occurs, and the buffer memory is not rewritten.

The A1S64AD then completes the A-D conversion processing according to the average time and the number of times before a setting error occurs.

3.7.4 Digital output value

A digital value converted from an analog value is stored in the buffer memory addresses 10 to 13 for every channel.

A digital output value is expressed in a 16-bit signed binary, with resolution 1/4000: -4096 to 4095, 1/8000: -8192 to 8191, and 1/12000: -12288 to 12287.

(A negative digital value is expressed in the 2's complement.)

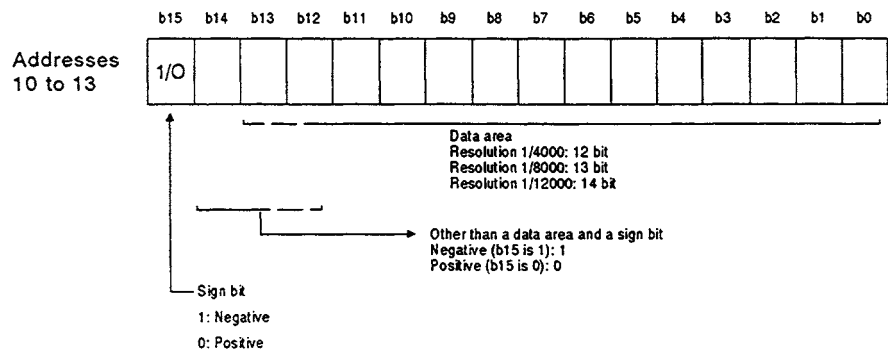

3.7.5 Writing data error code

- (1) When set data is written from the PC CPU, A1S64AD checks the range of data only one time and checks the access of the reading and writing area. When data is outside the range, error codes are stored to the buffer memory address 18 as a 16 bit binary value.

For details of an error code, see Section 6.1.

- (2) When several errors occur, the error code that occurred at first is stored in A1S64AD, and any errors after that are not stored.
- (3) The error code is reset by turning ON Y12 with a sequence program. (see Section 3.6.)
- (4) When an error is reset, the data error code becomes 0, and A1S64AD RUN LED turns ON.
- (5) If "0" is written in buffer memory address 18, an error is reset.

3.7.6 A-D conversion completed flag

- (1) When after turning ON a power supply and an A-D conversion READY signal (X1) turns ON, channels 1 to 4 have already completed all of the A-D conversion. Therefore, 000FH (15) is stored in the buffer memory.
- (2) Only when the A-D conversion-enable/disable setting (address 0) is changed, the A-D conversion completed flag processing after turning on a power supply is done one time.
 - When A-D conversion-disable is switched to enable
 When the averaging processing is specified, the averaging process for the average number of times or average time is completed, and a flag is set to 1 after storing a digital value translated from an analog value in the buffer memory.
 - When A-D conversion-enable is switched to disable
 The A-D conversion completed flag of a corresponding channel is set to 0.
- (3) There is an A-D conversion-completed flag classified by a channel.

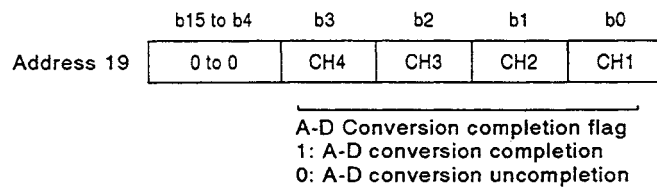

- (4) An A-D conversion-completed flag can be used as an interlock to read a digital value of a channel that the averaging process is done.

3.7.7 Resolution setting

- (1) The resolution of a digital output value is set to either 1/4000, 1/8000 or 1/12000. When a power supply is turned ON, a default is set to 1/4000.
- (2) Write "1 to 3" in buffer memory address 20 to set a resolution.

Set Data	Resolution
1	1/4000
2	1/8000
3	1/12000

POINT

Before setting the A-D conversion-enable/disable when a PC is RUN, set the resolution only one time.

If the resolution is changed when A-D conversion-enable is set, a correct digital output cannot be obtained.

4. PRE-OPERATION SETTINGS AND PROCEDURES

4.1 Handling Instructions

The following explains the handling instructions for the A1S64AD.

- (1) Protect the A1S64AD and its terminal block from impact.
- (2) Do not remove the printed circuit boards from their housing. There are no user-serviceable parts on the boards.
- (3) Make sure that no conductive debris can enter the module. Make sure that any debris is removed from the module. Guard particularly against cut off wires.
- (4) Tighten the terminal screws and mounting screws as specified below:

Screw	Tightening Torque Range
Module installation screw (M4 screw)	78 to 118 N-cm
I/O terminal screw (M3.5 screw)	59 to 88 N-cm
I/O terminal block installation screw (M4 screw)	78 to 118 N-cm

- (5) To install a module to the base unit, insert the module fixing hook into the module fixing hole on the base unit and tighten the module fixing screw. To remove a module, loosen the module fixing screw, and pull the module fixing hook out of the module fixing hole.

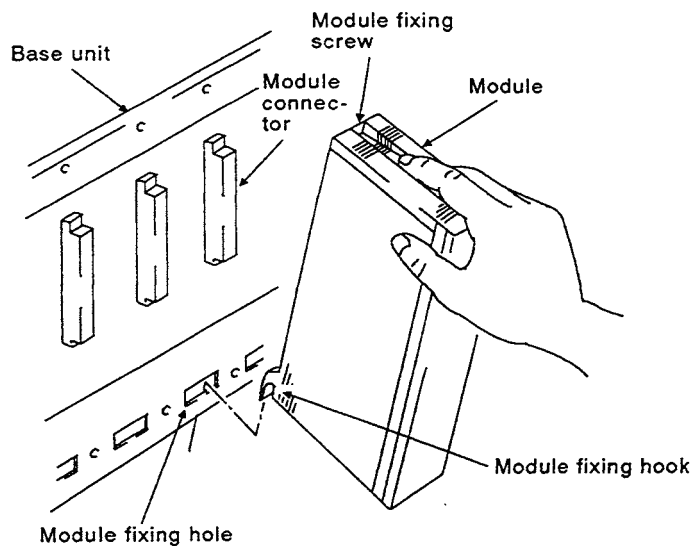

4. PRE-OPERATION SETTINGS AND PROCEDURES

MELSEC-A

4.2 Nomenclature

The following gives the nomenclature for each part of the A1S64AD.

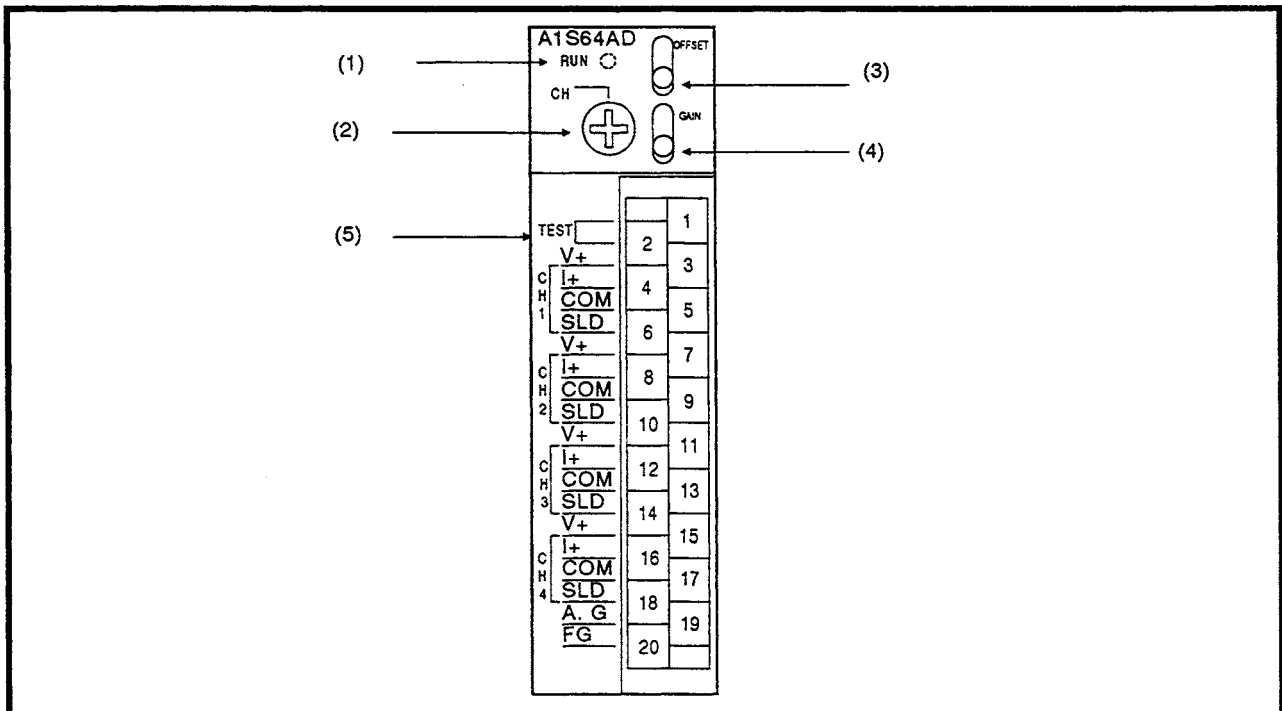

No.	Description	Application
(1)	<p>*RUN* LED</p>	<p>Indicates the operating status of the A1S64AD.</p> <p>(Normal mode)</p> <p>On: Indicates that the A1S64AD is operating without fault</p> <p>Flash: Writing data error occurred.</p> <p>Off: External power 5 VDC is not supplied to the A1S64AD or A1S64AD is in WDT error</p> <p>(Test mode)</p> <p>On: OFFSET or GAIN switch is ON.</p> <p>Off: OFFSET and GAIN switches are OFF.</p>
(2)	<p>Channel select switch</p>	<p>Used to specify the channel for the offset/gain adjustment. (Channel other than channels 1 to 4 is not processed.)</p>
(3)	<p>OFFSET switch</p>	<p>Stores the analog input value in A1S64AD as an offset value by setting the switch to the OFFSET side.</p>
(4)	<p>GAIN switch</p>	<p>Stores the analog input value in A1S64AD as an offset value by setting the switch to the GAIN side.</p>
(5)	<p>Test mode terminals</p>	<p>Connected between terminals No.1 and No.2 to set the offset/gain values.</p>

4.3 Offset/gain Setting

To change the I/O conversion characteristics, follow the steps below.

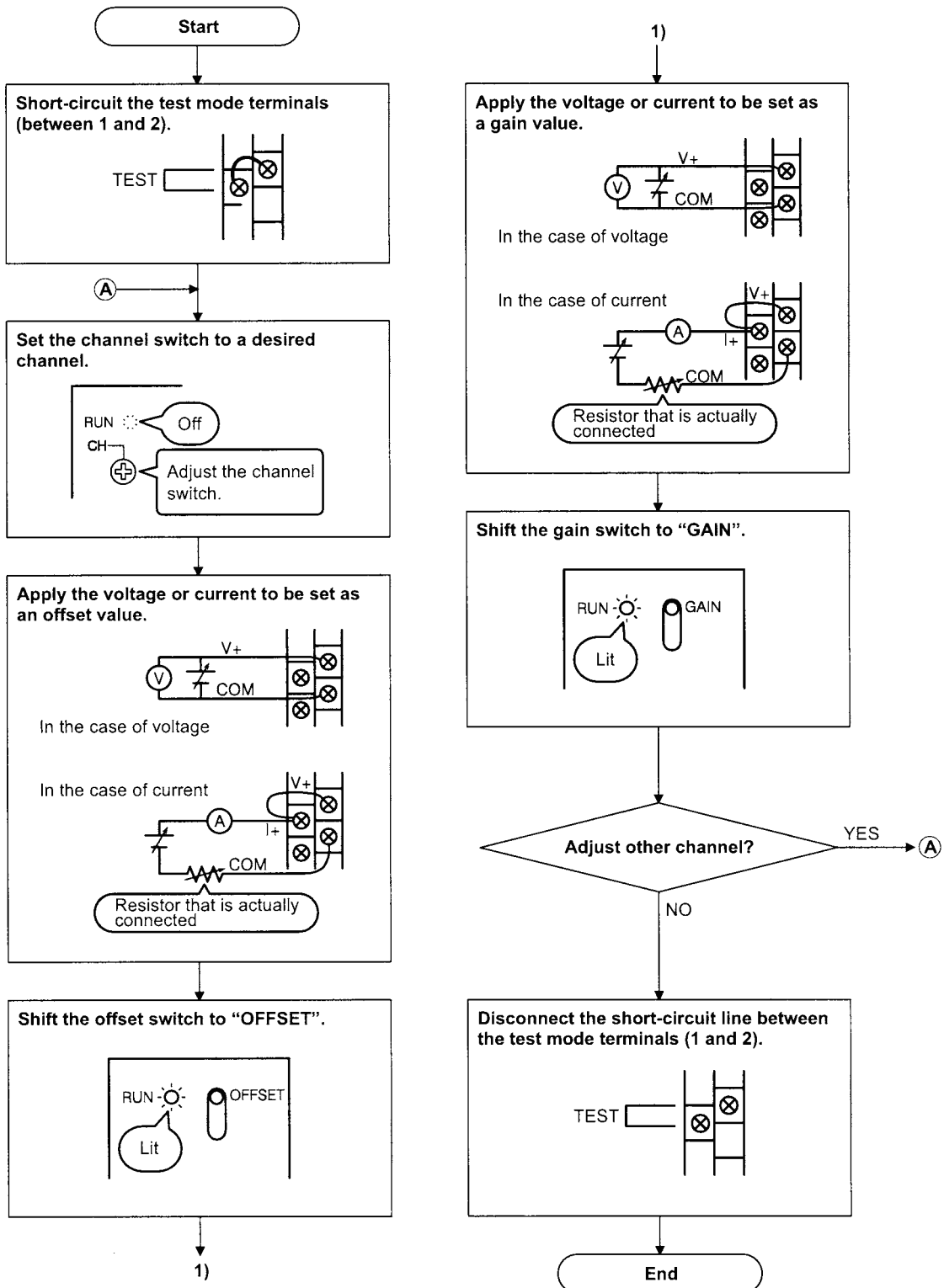

POINT

- (1) Set the offset and gain value according to the actual operation status.
- (2) The offset and gain values are stored in A1S64AD, and they are not cleared even if there is no power.
- (3) Set the offset and gain values when the PLC CPU is in the STOP mode. When the setting is done in the test mode, A-D conversion for all channels stops. Therefore, use the A-D conversion READY signal as an interlock.
- (4) Set the offset and gain value within the range -10 to 10 VDC, or -20 to 20 mA. When a value is set outside of this range, the maximum resolution and overall accuracy does not always match with the specification.
- (5) RUN LED will be lit even when the offset and gain values is set outside the applicable range as shown section 3.3.1 and 3.3.2.
- (6) When the grounding indicated with the "*" mark in Section 4.4.2 was changed (not execute execute, or execute \rightarrow remove), be sure to set the offset and gain value again from the beginning.

4.4 Wiring

This section explains the wiring instructions and gives a connection example of a module

4.4.1 Wiring instructions

Protect the external wiring against noise (extraneous signals) with the following precautions:

- (1) Separate AC and A1S64AD external input signal wiring that is not affected by a surge of alternating current and induction.
- (2) Separate the main circuit and/or the high voltage wiring from the control and signal wiring.
- (3) Where applicable, ground the shielding of all the wires to a common ground point.

4. PRE-OPERATION SETTINGS AND PROCEDURES

MELSEC-A

4.4.2 Connection example of module

(1) Voltage input

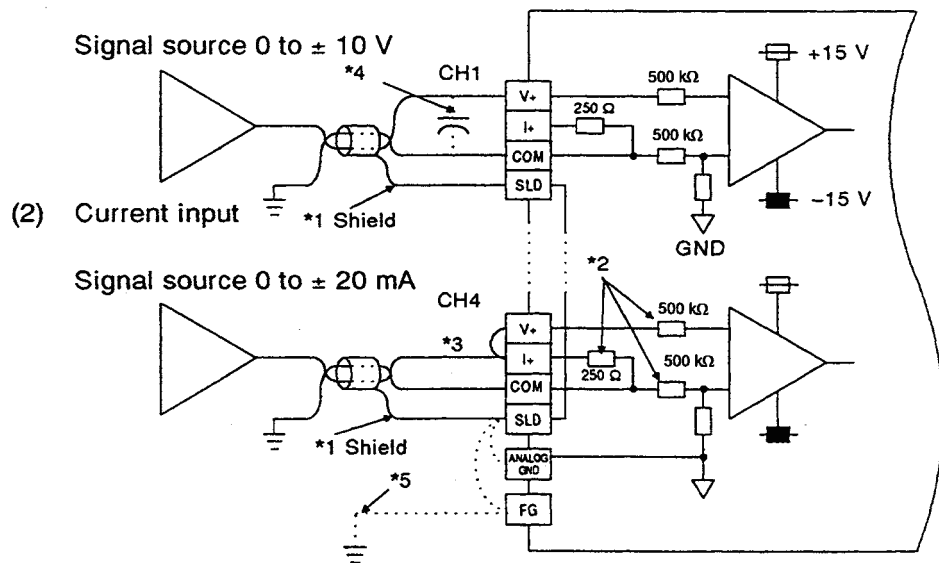

- *1: Use two-core shielded wiring (twisted).
- *2: Indicates the input resistance of the A1S64AD.
- *3: Connect (V+) and (I+) terminals for the current input.
- *4: If noise or ripple is generated the external wiring, connect a 0.1 to 0.47 μ F capacitor (approximate 25V or more withstand voltage) between the terminal V and COM.
- *5: Ground the shielding specifically for big noise (extraneous signals). The FG of a power supply module or the FG of this module should be grounded on such occasions. When the grounding wiring (grounding or not) is changed after setting offset and gain values, reset the offset and gain values.

4.5 Check and Maintenance

For ideal running conditions, follow the check items described in the CPU module User's Manual.

5. PROGRAMMING

This section explains the programming procedure, a basic program, and a read/write programming example when using the A1S64AD.

See to Section 3.7 for the buffer memory and the ACPU Programming Manual for the programming instruction details.

When applying any of the program examples introduced in this chapter to the actual system, full verify that there are no problems in the controllability of the target system.

5.1 Programming Procedure

When creating a program to execute the A-D conversion of A1S64AD use the following procedure.

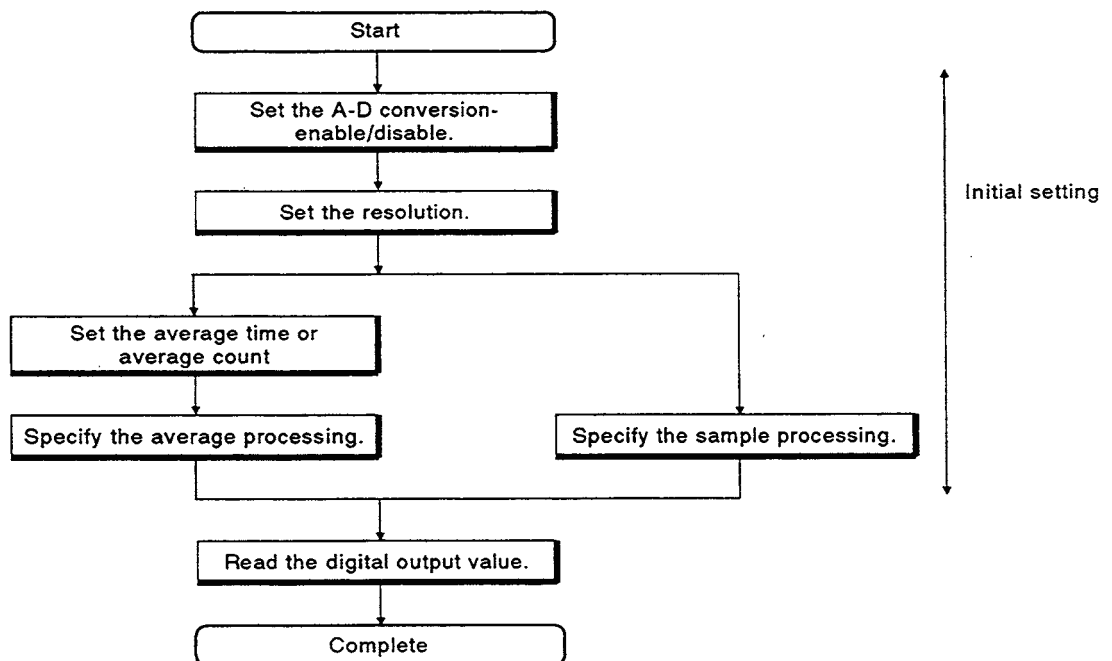

POINT

During the various processes of the special function modules, the access from the PLC CPU has the priority. Thus, if the special function module's buffer memory is frequently accessed from the PLC CPU, the scan time of the PLC CPU will increase, and the various processes of the special function module will also be delayed. Access the buffer memory from the PLC CPU using the FROM/TO commands only when necessary.

5.2 Basic Program for Read/Write

(1) Read from A1S64AD ... FROM, FROMP, DFRO, and DFROP instruction

Format

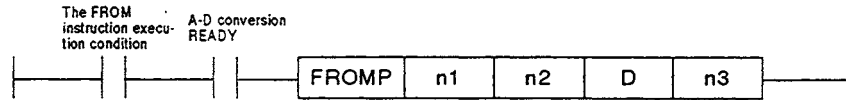

Symbol	Description	Device That Can be Used
n1	The first two (2) digits when the head I/O number is allocated to A1S64AD in three (3) digits of hexadecimal	K, H
n2	Head address of the buffer memory in which data is stored	K, H
D	Head number of the device in which data is stored	T,C,D,W,R
n3	Number of words of read data	K, H

Example

When the A1S64AD is allocated to I/O X130 to 14F and the Y130 to 14F, the data is read from address 10 of the buffer memory to one (1) word D0.

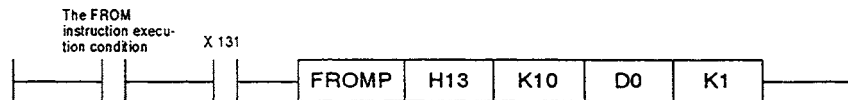

(2) Writing to A1S64AD ... TO, TOP, DTO, and DTOPI instruction

Format

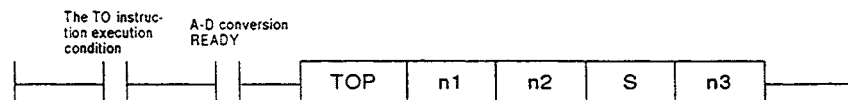

Symbol	Description	Device That Can be Used
n1	The first two (2) digits when the head I/O number is allocated to A1S64AD in three (3) digits of hexadecimal	K, H
n2	Head address of the buffer memory in which data is stored	K,H
S	Number or constant of a head device in which writing data is stored	T,C,D,W,R,K,H
n3	Number of words of write data	K,H

Example

When A1S64AD is allocated to I/O X60 to 7F and Y60 to 7F, 1 is written in address 0 of a buffer memory

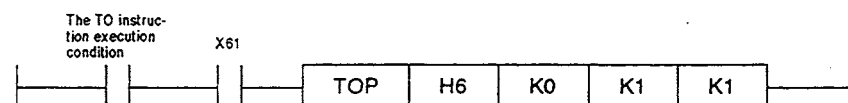

5.3 Initial Setting Program and Example of Digital Output Value Read Program

This programming example is used to read the digital output value converted from an analog value with the condition that the resolution is set to 1/8000 and that channels 1 to 3 are used.

Channel 1 is for the sample processing, channel 2 is for the average processing per 50 times, and channel 3 is for the average processing per 1000 msec. When a writing error occurs, an error code is displayed in BCD.

Sample condition of a program

(1) System configuration

Power supply module	A1S CPU	A1S 64 AD	A1S X41 32 points	A1S Y41 32 points		
		X/Y00 to X/Y1F	X20 to X3F	Y40 to Y5F) I/O number	

(2) Initial setting

- (a) A/D conversion-enabled channel 1, 2 and 3 channels
- (b) Average processing channel by count Channel 2, count setting: 50 times
- (c) Average processing channel by time Channel 3, time setting: 1000ms
- (d) Resolution..... "2" (1/8000)

(3) Device to be used by user

- (a) Initial setting command input signal X20
- (b) Writing data error reset signal X21
- (c) Digital output value read command input signal X22
- (d) Writing data error occurrence display X40
- (e) Writing data error code BCD output Y50 to 5B
- (f) Writing data error code storage data register D0
- (g) A-D conversion completed flag storage device M0 to M2
- (h) Digital output value read data register D10 to D12

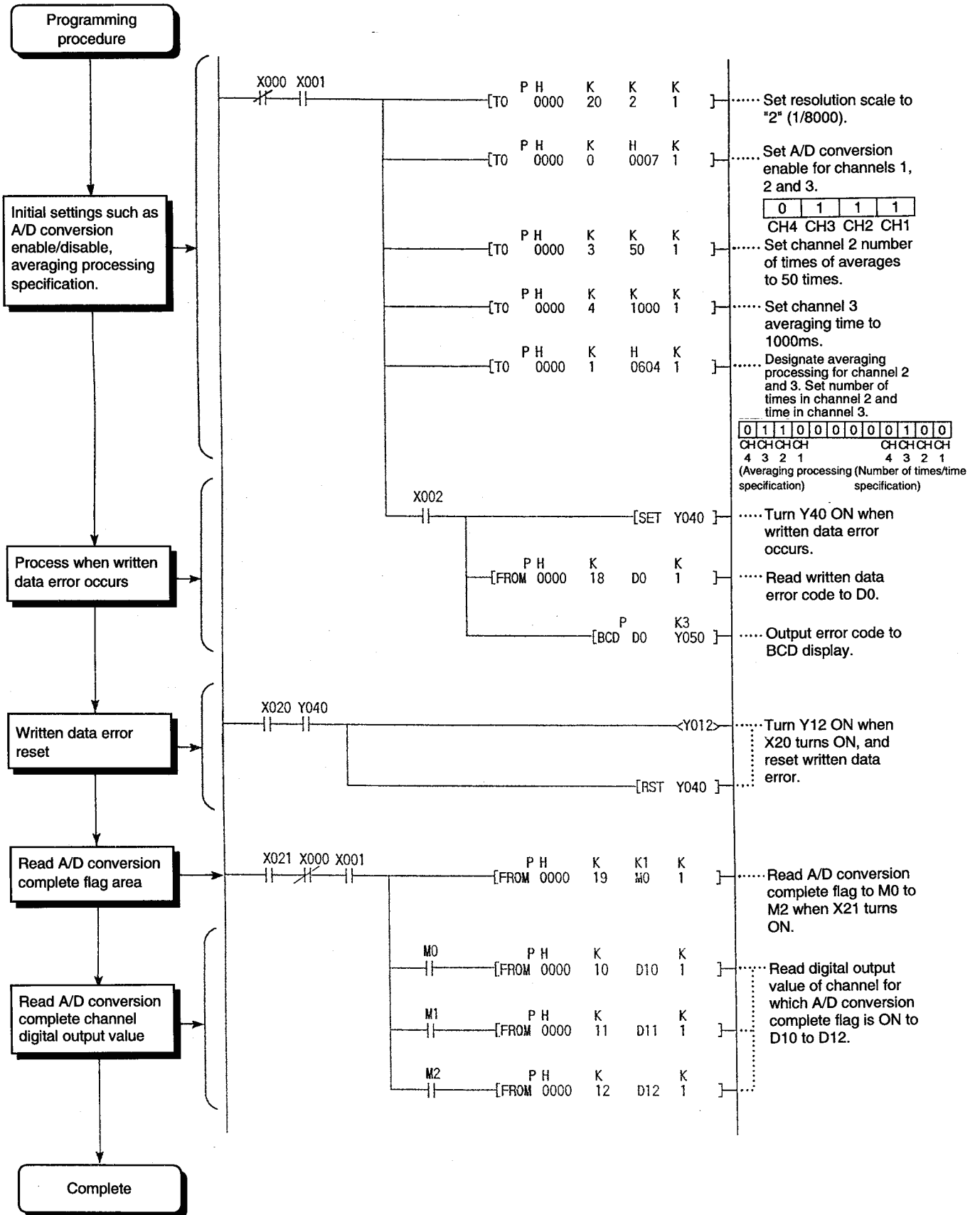

6. TROUBLESHOOTING

Assorted problem conditions and a troubleshooting guide for the A1S64AD are described below.

6.1 Error Code List

When data is written to an A1S64AD from a PLC CPU or an error occurs by reading data (RUN LED of A1S64AD flashes), the following error codes are stored in address 18 of the A1S64AD buffer memory.

Table 6.1 Error Code List (Detected with A1S64AD)

Error Code	Cause	Corrective Action
100	Wrong number (other than 1 to 3) was set to the resolution.	Set the resolution to either 1, 2, or 3.
102	Data was written to the read-only area (addresses 10 to 13).	Modify the specified place for the read-only area.
[] 0	<ul style="list-style-type: none"> A value outside 80 to 10000 ms was set for the average time. [] indicates the channel No. in which an error occurred. 	Set the average time within 80 to 10000 ms.
[] 5	<ul style="list-style-type: none"> A value outside 1 to 500 times was set for the average count. [] indicates the channel No. in which an error occurred. 	Set the average count within 1 to 500 times.

(1) When several errors occur, the error code that occurred first is stored, and any errors after that are not stored.

(2) The error code is reset by turning ON Y12 with a sequence program.

(See Section 3.6.)

6.2 Troubleshooting

The following explains the simple troubleshooting for A1S64AD. Refer to the CPU Module User's Manual for a PLC CPU module.

6.2.1 When the RUN LED of A1S64AD Flashes

Items to Check	Corrective Actions
Is the data which cannot be executed read/write written to A1S64AD?	Confirm the error cause with the error code list in Section 6.1, and correct the sequence program.

6.2.2 When the RUN LED of A1S64AD goes OFF

Items to Check	Corrective Actions
Are the TEST terminals opened?	Make offset/gain adjustments, and open the TEST terminals.
Is X0 (WDT error) set?	Reset the PLC CPU. If the RUN LED is not turned ON after resetting a PLC CPU, there may be a hardware malfunction in the module.

6.2.3 When the digital output value cannot be read

Items to Check	Corrective Actions
Is the RUN LED of A1S64AD flashing or turned OFF?	Follow the procedures in Section 6.2.1 or 6.2.2.
Is the ERROR LED of the CPU is turned ON?	Check the error description according to the CPU User's Manual.
Is the RUN LED of the CPU flashing or turned OFF?	Check the error description listed in the CPU User's Manual.
Is the condition to execute FROM instruction turned ON?	Monitor with a peripheral device such as GPP, and confirm whether it is ON or OFF.
Does the address of the buffer memory specified with a FROM instruction correspond to the address of the digital output value of channel to be read?	Check the sequence program.
Is the channel specified with FROM instruction set to A-D conversion enable?	Read the buffer memory address 0 and verify whether it is set to conversion enable or disable.
Is the conversion completed in the channel specified with FROM instruction ?	Read the buffer memory address 19 and verify the conversion completed flag.
Is the analog input signal line disconnected, or does an error occur?	Confirm the error by visually checking or conduction checking the signal line.
Disconnect the analog input wire of A1S64AD, and apply the test voltage to the terminal of this module to measure the digital output value.	If the digital output value is normal with an A1S64AD, the module is affected by noise with external wiring. Therefore, check the wiring and grounding method.

6.2.4 When the A-D conversion complete flag is not turned ON

Items to check	Corrective Action
Is A-D conversion set to be disabled?	Set A-D conversion to be enabled.
Is the offset and gain value set outside the applicable range?	Set the offset and gain value within the applicable range according to the procedures in Section 3.3.1 and 3.3.2.

6.2.5 When the digital output value of 0 does not change

Items to check	Corrective Action
Is the same value set to the offset and gain values?	Set the offset and gain values again.

APPENDICES

Appendix 1 Outside Dimensions

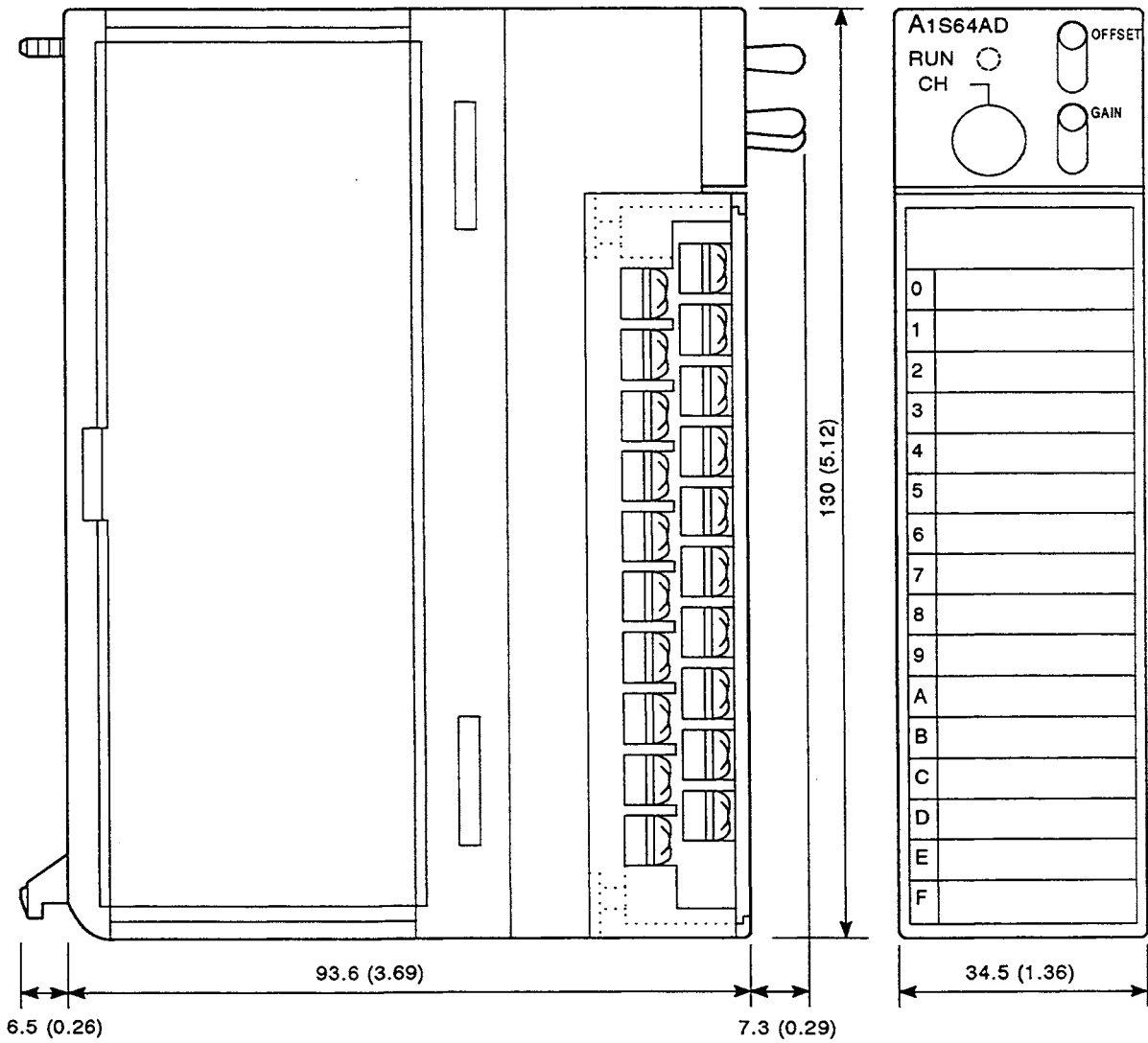

Unit: mm (in)

Appendix 2 Signal Paper

Front

0	
1	
2	
3	
4	
5	
6	
7	
8	
9	
A	
B	
C	
D	
E	
F	

Back

1	
2	
3	
4	
5	
6	
7	
8	
9	
10	
11	
12	
13	
14	
15	
16	
17	
18	
19	
20	

WARRANTY

Please confirm the following product warranty details before using this product.

1. Gratis Warranty Term and Gratis Warranty Range

If any faults or defects (hereinafter "Failure") found to be the responsibility of Mitsubishi occurs during use of the product within the gratis warranty term, the product shall be repaired at no cost via the sales representative or Mitsubishi Service Company.

However, if repairs are required onsite at domestic or overseas location, expenses to send an engineer will be solely at the customer's discretion. Mitsubishi shall not be held responsible for any re-commissioning, maintenance, or testing on-site that involves replacement of the failed module.

[Gratis Warranty Term]

The gratis warranty term of the product shall be for one year after the date of purchase or delivery to a designated place.

Note that after manufacture and shipment from Mitsubishi, the maximum distribution period shall be six (6) months, and the longest gratis warranty term after manufacturing shall be eighteen (18) months. The gratis warranty term of repair parts shall not exceed the gratis warranty term before repairs.

[Gratis Warranty Range]

- (1) The range shall be limited to normal use within the usage state, usage methods and usage environment, etc., which follow the conditions and precautions, etc., given in the instruction manual, user's manual and caution labels on the product.
- (2) Even within the gratis warranty term, repairs shall be charged for in the following cases.
 1. Failure occurring from inappropriate storage or handling, carelessness or negligence by the user. Failure caused by the user's hardware or software design.
 2. Failure caused by unapproved modifications, etc., to the product by the user.
 3. When the Mitsubishi product is assembled into a user's device, Failure that could have been avoided if functions or structures, judged as necessary in the legal safety measures the user's device is subject to or as necessary by industry standards, had been provided.
 4. Failure that could have been avoided if consumable parts (battery, backlight, fuse, etc.) designated in the instruction manual had been correctly serviced or replaced.
 5. Failure caused by external irresistible forces such as fires or abnormal voltages, and Failure caused by force majeure such as earthquakes, lightning, wind and water damage.
 6. Failure caused by reasons unpredictable by scientific technology standards at time of shipment from Mitsubishi.
 7. Any other failure found not to be the responsibility of Mitsubishi or that admitted not to be so by the user.

2. Onerous repair term after discontinuation of production

- (1) Mitsubishi shall accept onerous product repairs for seven (7) years after production of the product is discontinued. Discontinuation of production shall be notified with Mitsubishi Technical Bulletins, etc.
- (2) Product supply (including repair parts) is not available after production is discontinued.

3. Overseas service

Overseas, repairs shall be accepted by Mitsubishi's local overseas FA Center. Note that the repair conditions at each FA Center may differ.

4. Exclusion of loss in opportunity and secondary loss from warranty liability

Regardless of the gratis warranty term, Mitsubishi shall not be liable for compensation of damages caused by any cause found not to be the responsibility of Mitsubishi, loss in opportunity, lost profits incurred to the user by Failures of Mitsubishi products, special damages and secondary damages whether foreseeable or not, compensation for accidents, and compensation for damages to products other than Mitsubishi products, replacement by the user, maintenance of on-site equipment, start-up test run and other tasks.

5. Changes in product specifications

The specifications given in the catalogs, manuals or technical documents are subject to change without prior notice.

6. Product application

- (1) In using the Mitsubishi MELSEC programmable logic controller, the usage conditions shall be that the application will not lead to a major accident even if any problem or fault should occur in the programmable logic controller device, and that backup and fail-safe functions are systematically provided outside of the device for any problem or fault.
- (2) The Mitsubishi programmable logic controller has been designed and manufactured for applications in general industries, etc. Thus, applications in which the public could be affected such as in nuclear power plants and other power plants operated by respective power companies, and applications in which a special quality assurance system is required, such as for Railway companies or Public service purposes shall be excluded from the programmable logic controller applications.

In addition, applications in which human life or property that could be greatly affected, such as in aircraft, medical applications, incineration and fuel devices, manned transportation, equipment for recreation and amusement, and safety devices, shall also be excluded from the programmable logic controller range of applications.

However, in certain cases, some applications may be possible, providing the user consults their local Mitsubishi representative outlining the special requirements of the project, and providing that all parties concerned agree to the special circumstances, solely at the users discretion.

A/D Converter Module Type A1S64AD

User's Manual

MODEL	A1S64AD-U-E
MODEL CODE	13J676
IB(NA)-66336-E(0609)MEE	

 **MITSUBISHI ELECTRIC CORPORATION**

HEAD OFFICE : TOKYO BUILDING, 2-7-3 MARUNOUCHI, CHIYODA-KU, TOKYO 100-8310, JAPAN
NAGOYA WORKS : 1-14, YADA-MINAMI 5-CHOME, HIGASHI-KU, NAGOYA, JAPAN

When exported from Japan, this manual does not require application to the Ministry of Economy, Trade and Industry for service transaction permission.

Specifications subject to change without notice.